

# CLOU DUO

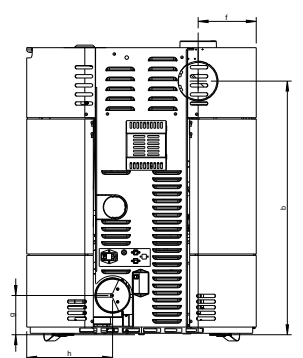

AUSTROFLAMM

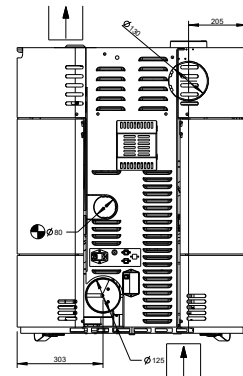
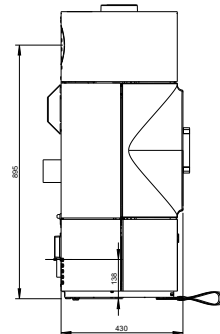
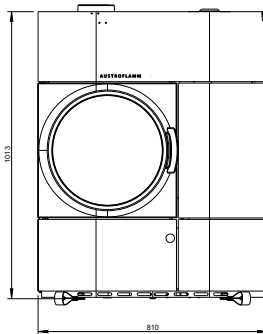
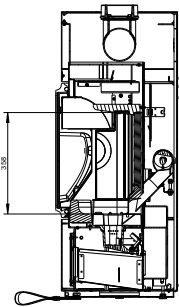
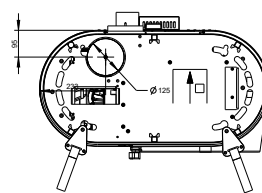
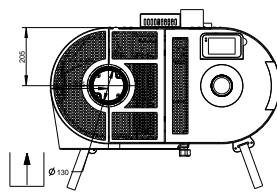
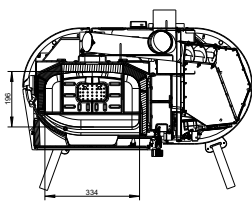

Dimensions and weight	
Height [mm]	1013
Width [mm]	810
Depth [mm]	430
Combustion chamber width [mm]	334
Combustion chamber height [mm]	358
Combustion chamber depth [mm]	196
Flue pipe outlet, diameter [mm]	130
Outside air connection diameter [Ø mm]	125
Weight, basic appliance [kg]	212
Weight Xtra [kg]	-
Total weight inc. steel case (STM) [kg]	212
Total weight inc. ceramic case (KGM) [kg]	-
Total weight inc. soapstone case (SPM) [kg]	-
b: Height of flue pipe connection, centre rear (as per diagram) [mm]	895
f: Flue pipe connection from right (as per diagram) [mm]	205
g: Height of external air connection, centre (as per diagram) [mm]	138
h: External air connection from left (as per diagram) [mm]	303
a: Safety distance to combustible materials, front [mm]	750
b: Safety distance to combustible materials, left [mm]	150
c: Safety distance to combustible materials, rear [mm]	100
d: Safety distance to combustible materials, right [mm]	150
Safety distance to combustible materials, floor [mm]	0
Minimum distance from non-flammable materials [mm]	50
Output	
Nominal heat efficiency [kW]	7.0
Minimum heat output [kW]	2.3
Maximum heat output [kW]	7.0
Minimum room heating capacity [m³]	82
Maximum room heating capacity [m³]	210
Pellet hopper capacity [kg/l]	22 / 34
Minimum fuel throughput [kg/h]	0.6
Maximum fuel throughput [kg/h]	1.66
Burning time, minimum [h]	13
Burning time, maximum [h]	36
Power connection [V/Hz]	230 / 50
Data for the chimney sweep	
Exhaust gas mass flow [g/s]	4.8
Flue gas temperature [°C]	226
Minimum delivery pressure at nominal heat output [Pa]	12
Minimum delivery pressure for chimney calculation [Pa]	12
Equipment	
Room temperature sensor	Standard
Weekly timer	Standard
Automatic drop grate	Standard
Ash removal	
Balanced flue - DiBt (German Institute for Structural Engineering)	Submitted
WLAN module	Accessories
Remote control	Accessories
Air distribution module	Accessories

- not available