

Montageanleitung / Assembly instructions  
Instructions de montage  
Istruzioni di montaggio

## Herdplatte AO AH

Hotplate AO AH

Plaque de cuisson AO AH

Racc. sup. fumi post. piano cottura



**AUSTROFLAMM**

[www.austroflamm.com](http://www.austroflamm.com)

**085004-110, 085005-110**

Originalbetriebsanleitung  
26/05/2026

Version: 1.0

#### IMPRESSUM

Eigentümer und Herausgeber

AUSTROFLAMM GMBH  
Austroflamm-Platz 1  
A- 4631 Krenglbach  
Tel: +43 (0) 7249 / 46 443  
[www.austroflamm.com](http://www.austroflamm.com)  
[info@austroflamm.com](mailto:info@austroflamm.com)

Redaktion: Austroflamm GmbH

Abbildungen: Konstruktion

Text: Technische Abteilung (Austroflamm)

#### Copyright

Alle Rechte vorbehalten. Der Inhalt dieser Anleitung darf nur mit Genehmigung des Herausgebers vervielfältigt oder verbreitet werden! Druck-, Rechtschreib- und Satzfehler vorbehalten.

Die Informationen in diesem Dokument können ohne vorherige Ankündigung geändert werden und stellen keine Verpflichtung seitens der Austroflamm GmbH dar. Für eventuelle Fehler in diesem Dokument übernimmt die Austroflamm GmbH keine Haftung.

## Inhaltsverzeichnis

Deutsch.....	4
English .....	6
Français.....	8
Italiano .....	10

# 1 Allgemeines

## 085004-110, 085005-110 Herdplatte AO + AH

Geeignet für folgende Öfen:

- 085001 Luca Cook, Index c und Neueste

Herdplatte AO

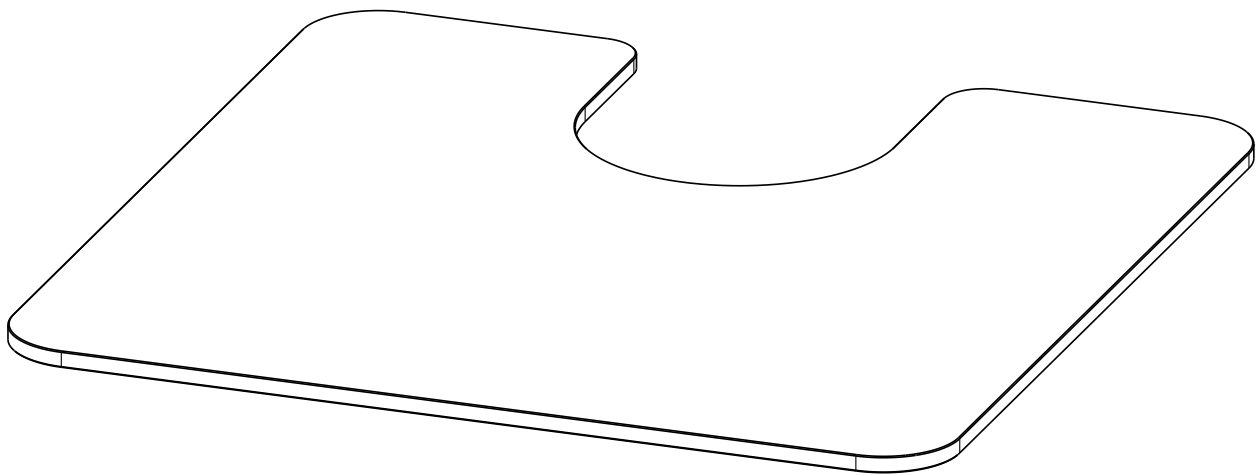

Pos. Nr.	Anzahl	Artikel	Artikel-Nr.
1	1	Herdplatte AO	085004-110

Herdplatte AH

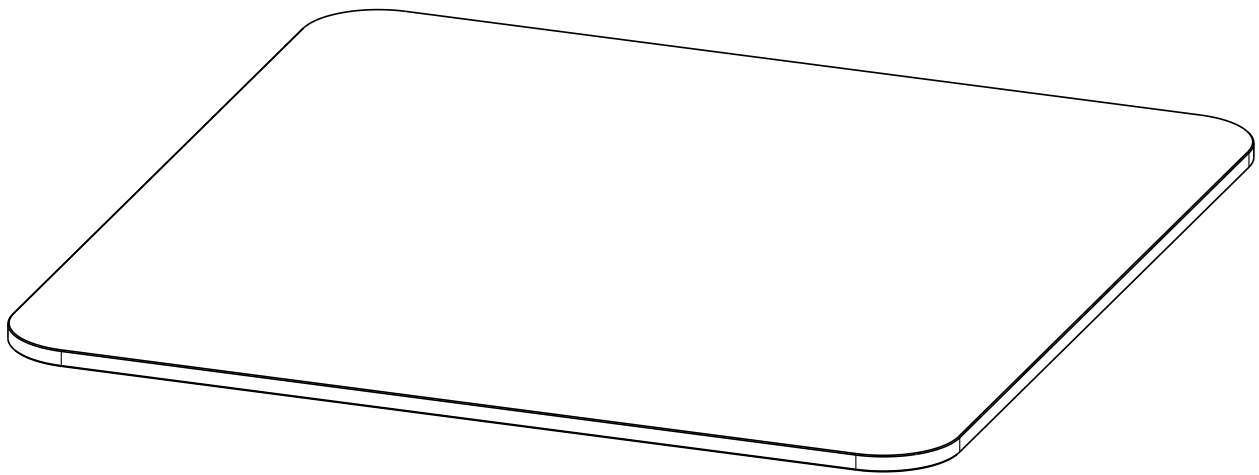

Pos. Nr.	Anzahl	Artikel	Artikel-Nr.
1	1	Herdplatte AH	085005-110

## 2 Montage

Angeführte Schutzausrüstung und Werkzeuge werden für die folgenden Arbeitsschritte benötigt

Art der Schutzausrüstung	
	Sicherheitshandschuhe
	Sicherheitsschuhe

Arbeitsmittel	Tätigkeit
Isolierte Werkzeuge	Um den Lack nicht zu beschädigen oder zu zerkratzen, sollten keine scharfen Gegenstände oder Werkzeuge verwendet werden. Stattdessen werden beim Zusammenbauen und Zerlegen von Teilen am Ofen bevorzugt <b>isolierte Werkzeuge</b> verwendet.
Torxschlüssel-Set	diverse Montagearbeiten
Inbusschlüssel-Set	diverse Montagearbeiten
Gabelschlüssel-Set	diverse Montagearbeiten

Die Montage darf ausschließlich vom autorisierten Fachbetrieb durchgeführt werden.

### 2.1 Herdplatte AO + AH montieren

Beide Herdplatten werden auf die gleiche Weise montiert.

- 1) Die Herdplatte am Kaminofen anbringen.



Abb. 1: Herdplatte anbringen

## 3 Demontage

Die Demontage erfolgt auf die jeweils umgekehrte Reihenfolge.

## 1 General

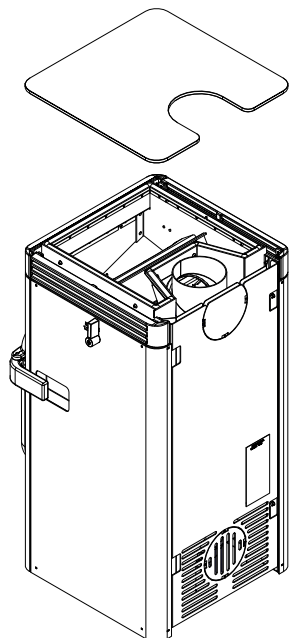
### 085004-110, 085005-110 Hotplate AO + AH

Suitable for the following stoves:

- 085001 Luca Cook, Index c and newer

Hotplate AO

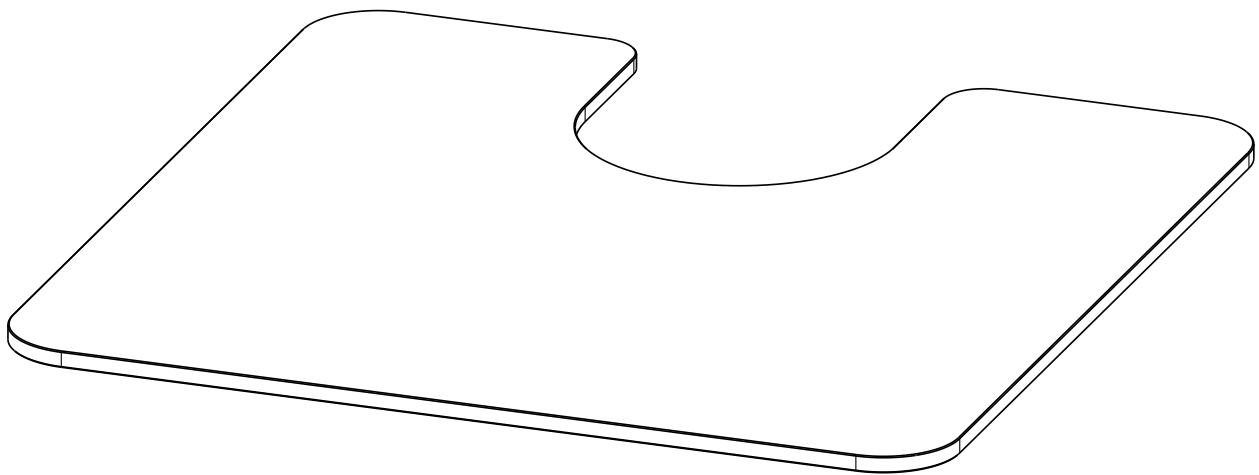

Item no.	Quantity	Article	Article no.
1	1	Hotplate AO	085004-110

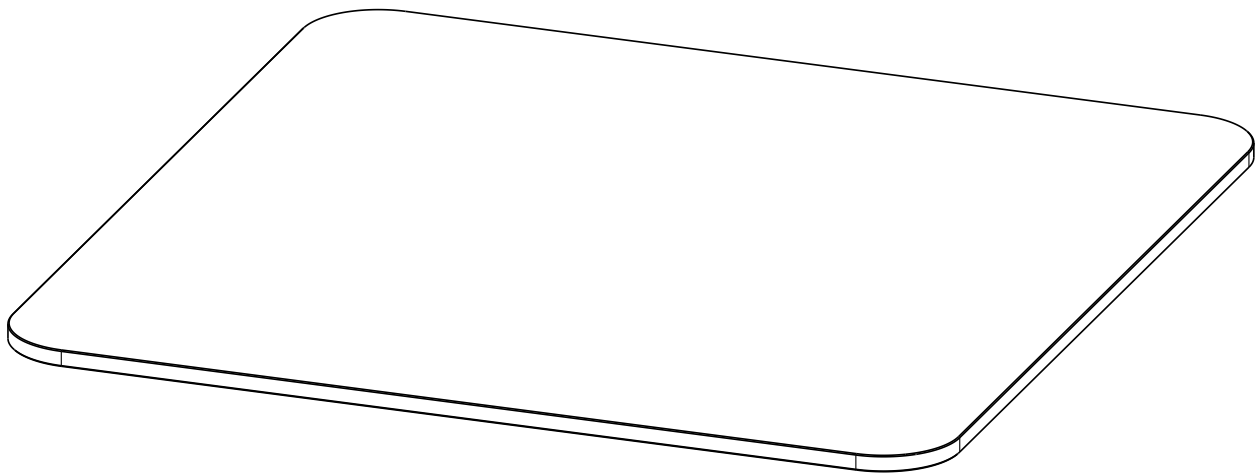

Hotplate AH



Item no.	Quantity	Article	Article no.
1	1	Hotplate AH	085005-110

## 2 Installation

The protective equipment and tools listed are required for the following work steps

Type of protective equipment	
	Safety gloves
	Safety shoes

Work equipment	Activity
Insulated tools	In order not to damage or scratch the varnish, no sharp objects or tools should be used. Instead <b>insulated tools</b> are used by preference when assembling and disassembling stove parts.
Torx wrench set	various installation jobs
Allen key set	various installation jobs
Fork wrench set	various installation jobs

Installation must only be carried out by an authorized specialist company.

### 2.1 Installing the top flue connection + rear flue connection hotplate

Both hotplates are mounted in the same way.

- 1) Install the hotplate on the stove.

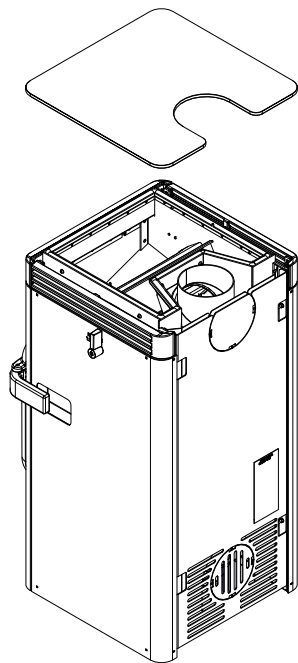

Fig. 1: Installing the hotplate

## 3 Disassembling

Disassembly is carried out in the reverse order.

## 1 Généralités

### 085004-110, 085005-110 Plaque de cuisson AO + AH

Convient aux poêle :

- 085001 Luca Cook, Index c et plus récents

Plaque de cuisson AO

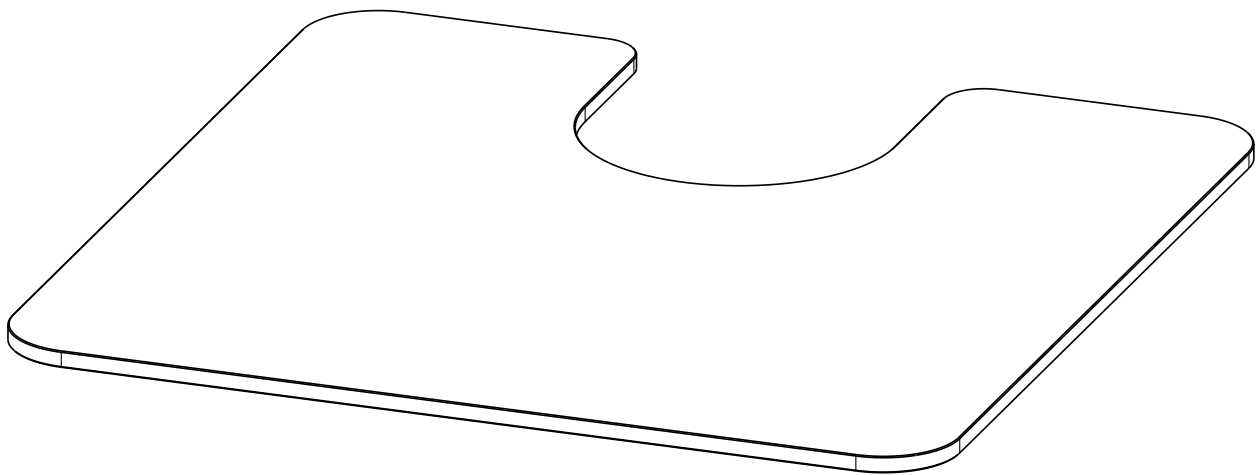

Pos. n°	Quantité	Article	Article n°
1	1	Plaque de cuisson AO	085004-110

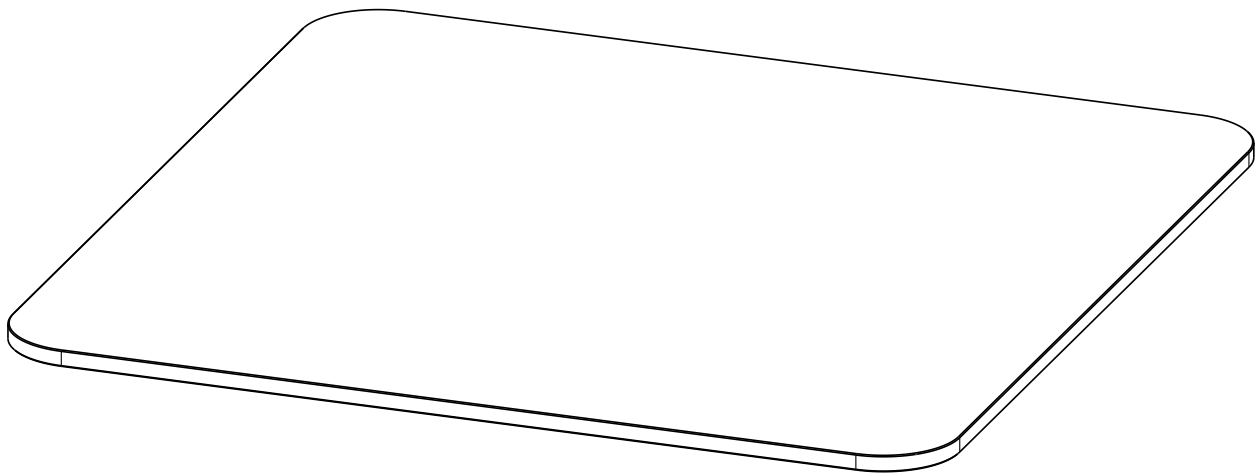

Plaque de cuisson AH



Pos. n°	Quantité	Article	Article n°
1	1	Plaque de cuisson AH	085005-110

## 2 Montage

L'équipement de protection et les outils indiqués sont nécessaires pour les étapes de travail suivantes

Type d'équipement de protection	
	Gants de sécurité
	Chaussures de sécurité

Outils	Activité
Outils isolés	Pour éviter d'endommager ou de rayer la peinture, ne pas utiliser d'objets ou d'outils tranchants. Il est préférable d'utiliser à la place des <b>outils isolés</b> pour assembler et démonter les pièces du poêle.
Jeu de clés Torx	Divers travaux d'assemblage
Jeu de clés à six pans	divers travaux d'assemblage
Jeu de clés à fourche	Divers travaux d'assemblage

Le montage doit être réalisé exclusivement par une entreprise spécialisée agréée.

### 2.1 Installer la plaque de cuisson AO + AH

Ces deux plaques de cuisson s'installent de la même manière.

- 1) Poser la plaque de cuisson sur le poêle à bois.

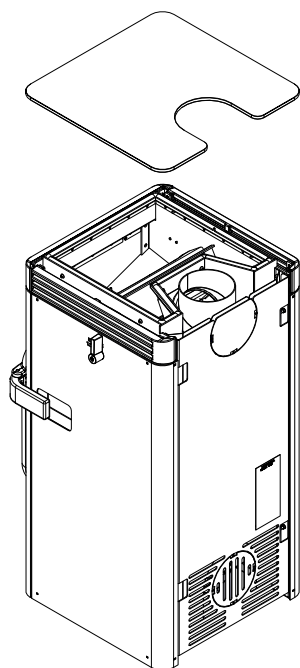

Fig. 1: Poser la plaque de cuisson

## 3 Démontage

Le démontage s'effectue dans l'ordre inverse.

## 1 Generalità

### 085004-110, 085005-110 Racc. sup. + fumi post. piano cottura

Adatto per i seguenti stufe:

- 085001 Luca Cook, Index c e più recenti

Racc. fumi sup. piano cottura

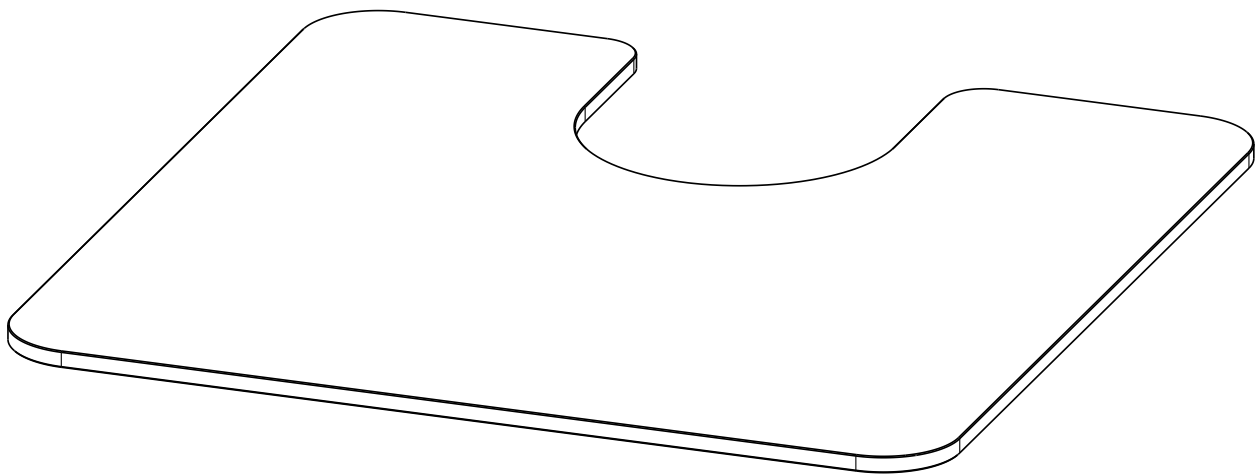

N. pos.	Q.tà	Articolo	N. art.
1	1	Racc. fumi sup. piano cottura	085004-110

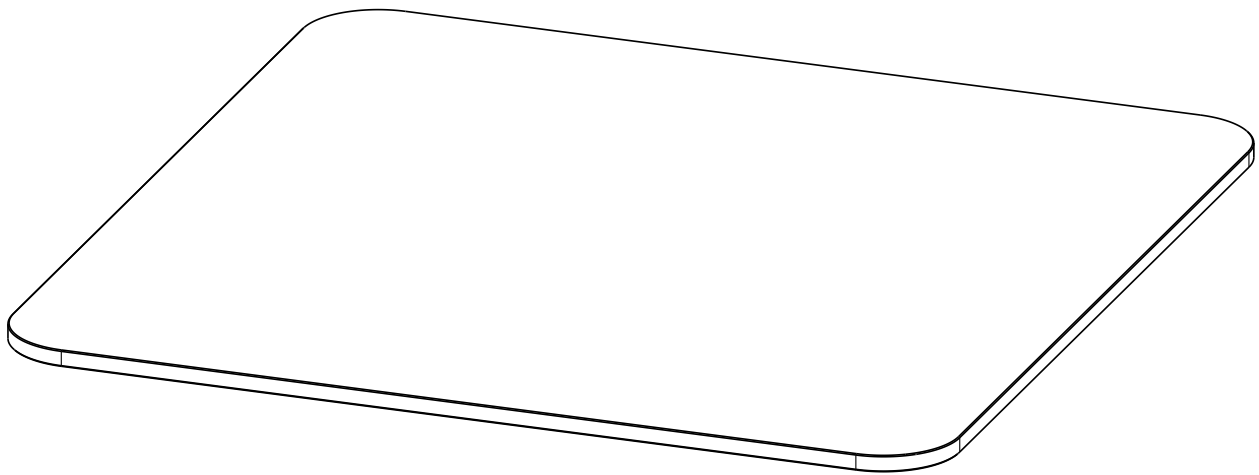

Racc. fumi post. piano cottura



N. pos.	Q.tà	Articolo	N. art.
1	1	Racc. fumi post. piano cottura	085005-110

## 2 Montaggio

Per le seguenti fasi di lavoro sono necessari i seguenti dispositivi di protezione e strumenti

Tipo di dispositivo di protezione	
	guanti di sicurezza
	scarpe di sicurezza

Strumenti di lavoro	Attività
Utensili isolati	Per evitare di danneggiare o graffiare la verniciatura, non si devono usare oggetti o utensili appuntiti. Per il montaggio e lo smontaggio delle parti del forno è preferibile utilizzare <b>utensili isolati</b> .
Kit chiavi Torx	vari interventi di montaggio
Set di chiavi a brugola	vari interventi di montaggio
Kit chiave a bocca	vari interventi di montaggio

Il montaggio deve essere effettuato solo da una ditta specializzata autorizzata.

### 2.1 Montaggio del piano cottura racc. fumi sup. + post.

Entrambi i piani cottura vengono montati allo stesso modo.

- 1) Collocare il piano cottura sulla stufa a caminetto.

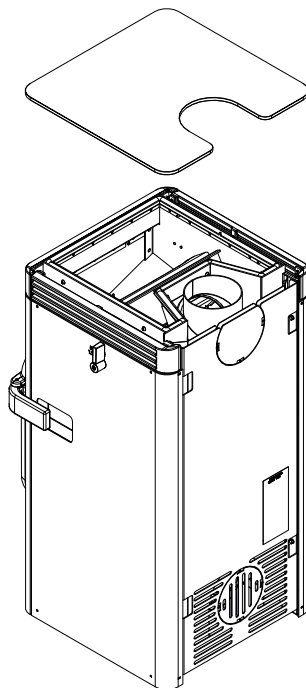

Fig. 1: Collocazione del piano cottura

## 3 Smontaggio

Lo smontaggio avviene nell'ordine inverso.

AUSTROFLAMM GMBH  
Austroflamm-Platz 1  
A- 4631 Krenglbach

Tel: +43 (0) 7249 / 46 443  
[www.austroflamm.com](http://www.austroflamm.com)  
[info@austroflamm.com](mailto:info@austroflamm.com)

945352

